



YLI ELECTRONIC

# Electric Bolt with Cylinder

Model: YB-620(LED)



## Parameters

Lock Body	150Lx36Wx57H(mm)
Magnetic Plate	150Lx36Wx3H(mm)
Bolt	16(prolongation)*20(diameter)(mm)
Voltage	12VDC
Current	Start 1000mA,Standby 350mA
Time Delay	0/3/6/9 sec
Feature	Fail secure
Signal Output	Door signal(NO/COM) Lock signal(NO/NC/COM)
LED	Light on indicates locked, light off indicates unlocked
Detection Distance	Within 3-8mm
Suitable for	Wooden door, metal door, fireproof door, glass door
Material	304 stainless steel, wire draw finishing
Weight	1.25kg

## Dimensions

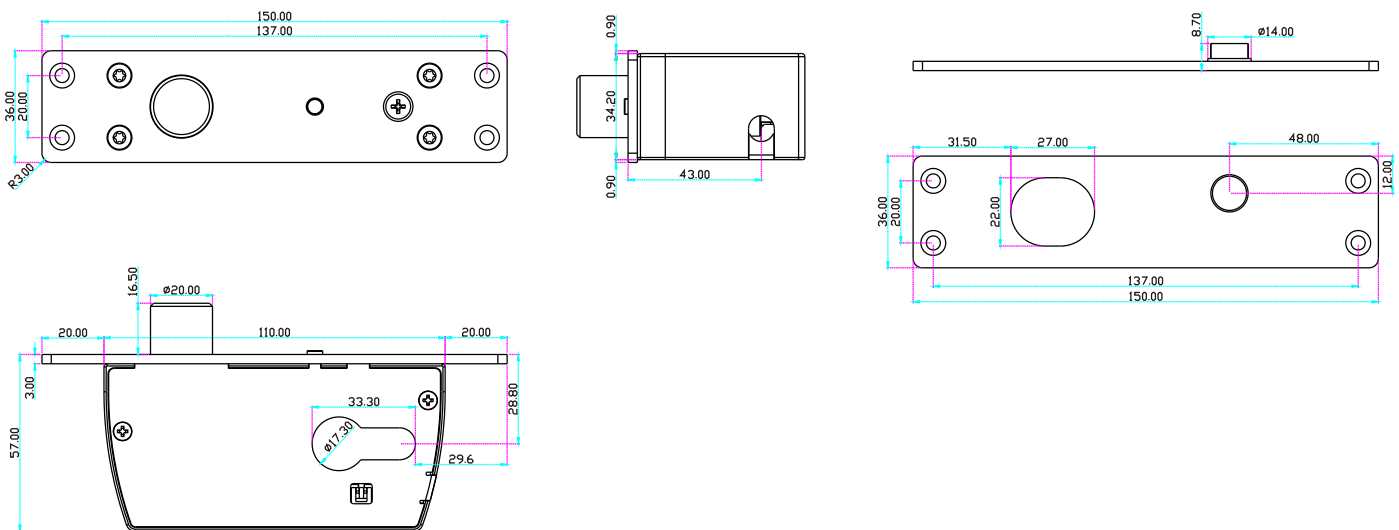

We create security

## Optional Accessory

Single side cylinder or both side cylinder, other sizes are available too: 80/90/100/110/120mm.

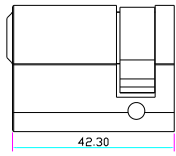
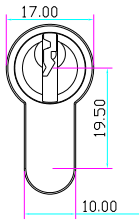

Single side cylinde

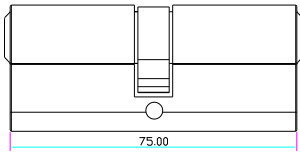
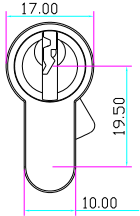

Double side cylinder

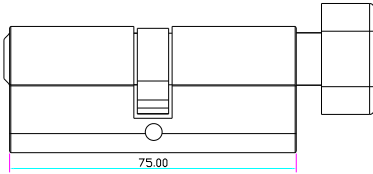
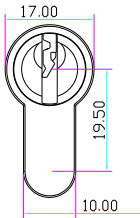

Single side cylinder with Thumb

## Wiring Diagram

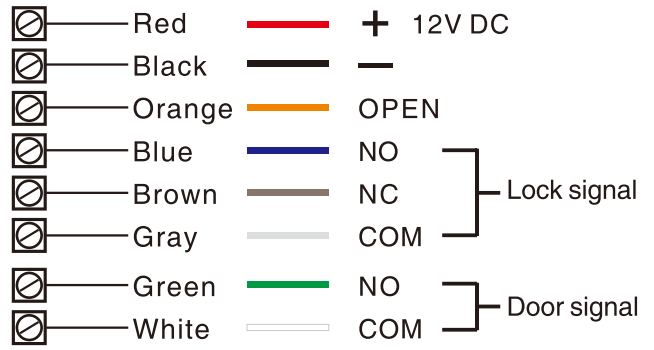

## Time Delay

Adjust the delay time for locking automatically 0/3/6/9 secs.



0.0 SEC



6.0 SEC



3.0 SEC



9.0 SEC

## Installation steps

