



YLI ELECTRONIC

Single Door Magnetic Lock with Camera



Model: YM-280CAM

Specification

Lock Size	280Lx48Wx26.5H(mm)
Holding Force	280kg(600Lbs)
Voltage	DC12V / DC24V+10%
Current	12V/600mA 24V/300mA
Signal Output	NO/NC/COM
LED Indication	Red shows unlocked ;Green shows locked
Time Delay	0/3/6/9sec adjustable
Suitable for	Wooden door , Glass door ,Metal door , Fireproof door
Video Pattern	PAL/NTSC
Resolution Ratio	550TVL
Video Output	1Vp-p (75Ω/BNC)
Visual Range	7m
Weight	2.4kg

Diagram(unit:mm)

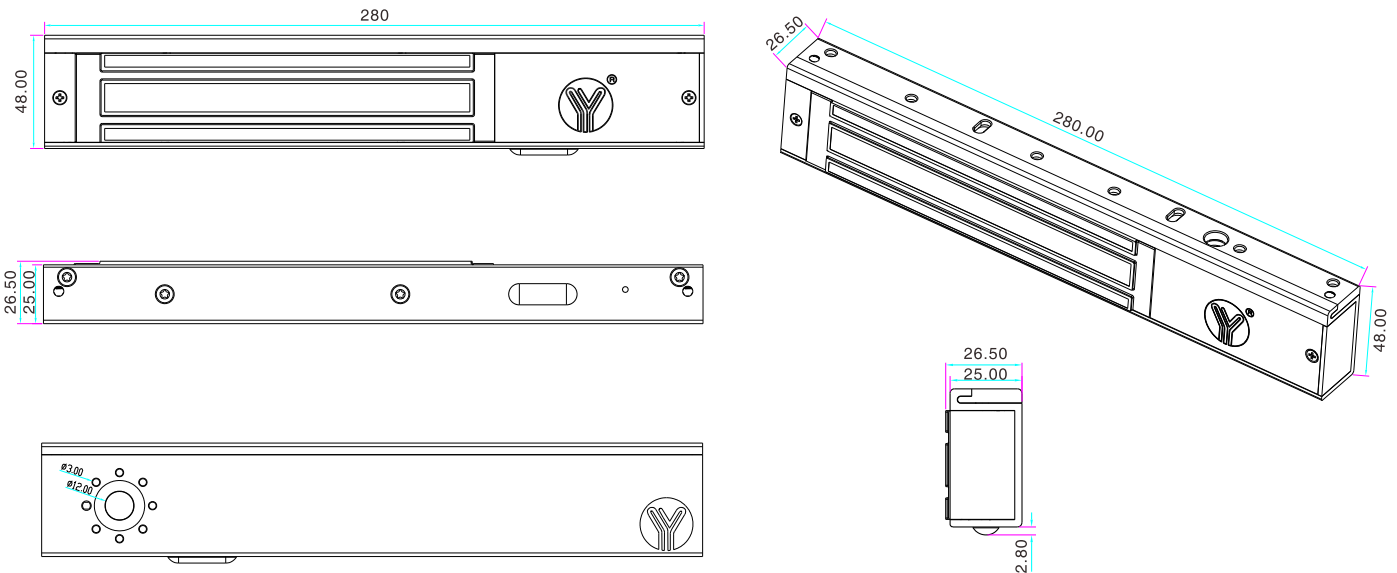

⚠ Cautions:

- A. The screw of armature plate should not be fixed too tight. Proper elasticity should be guaranteed for the rubber ring so that the armature plate can adjust itself to the appropriate position.
- B. Check the jumper's position before connecting. Figure out it represents 12VDC or 24VDC.

We create security

Installation

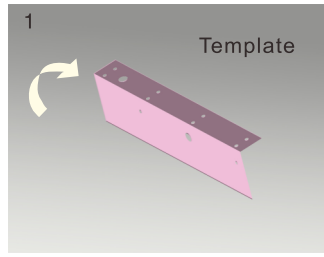
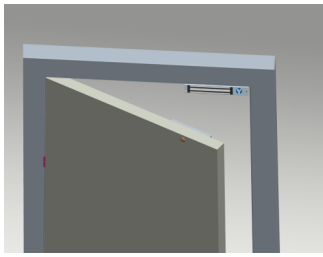

1 Fold the plate to 90° .

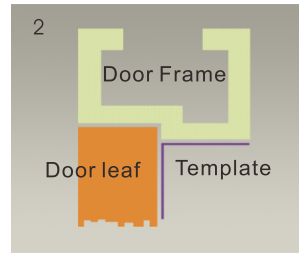

2 Close the door first, then place the upper side of template on door frame, while adjust the left side next to the door leaf.

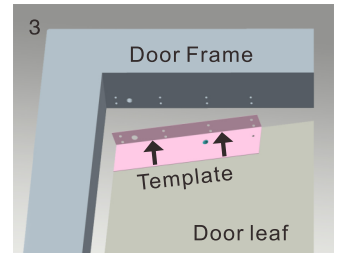

3 Mark screw positions of armature plate and magnetic lock on door leaf and door frame respectively.

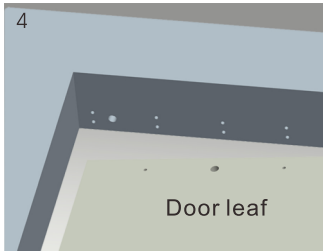

4 Drill holes based on the marked positions.

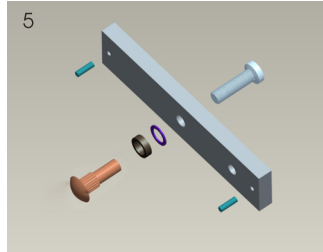

5 Make a combination based on the picture.

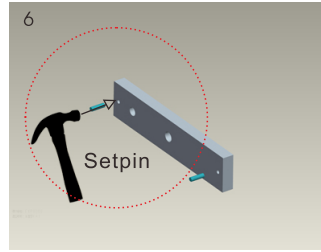

6 Strike the pin into the armature plate slightly (to avoid movement).

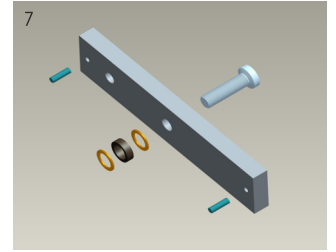

7 Make a combination based on the picture (add washer accordingly). The rubber ring must be added.

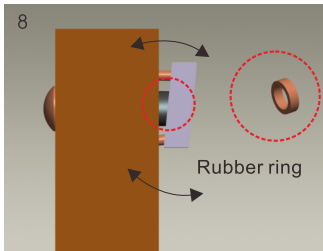

8 Place the rubber ring between armature plate and door leaf.

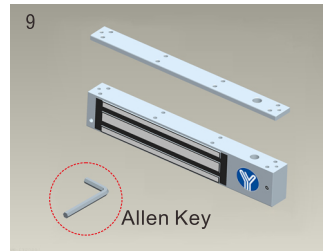

9 Use Allen key to remove the mounting plate from lock body.

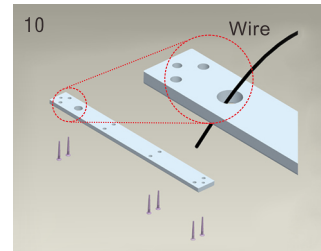

10 Fix the mounting plate on the door frame according to the holes drilled earlier.

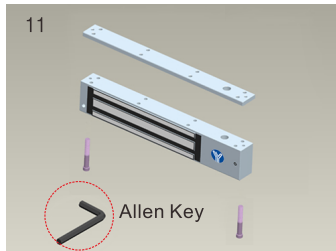

11 Use Allen key to screw the lock body on the mounting plate.

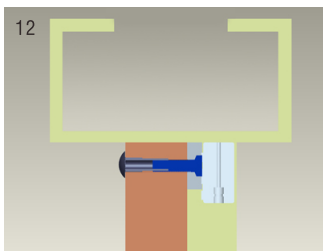

12 Close the door to test holding force. The angle between armature plate and magnetic lock can be adjusted by adding or reducing washers.

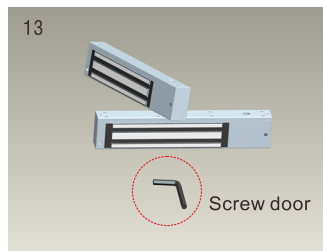

13 After all the appropriate procedures, the holding force can be maximized. Finally, fix the tamper screw.

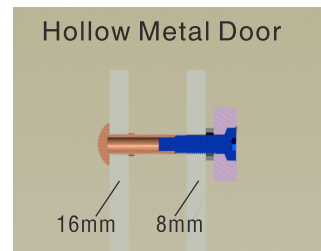

Hollow Metal Door
Drill a hole
Inside: Diameter is 8mm
Outside: Diameter is 16mm

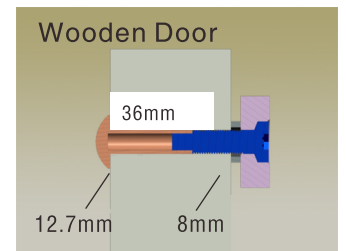

Wooden Door
Drill a hole
Inside: Diameter is 8mm
Outside: Diameter is 12.7mm

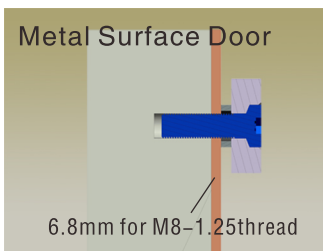

Metal Surface Door
Inside: Drill a hole diameter is 8mm folding the plastic straight pin

Notice:

Thickness of Door Leaf:

350LBS: 44mm

600LBS: 50mm

800LBS: 48mm

1200LBS: 46mm

Bracket Installation

Different brackets are available according to different types of doors. For example, narrow door, frameless glass door and inward opening door.

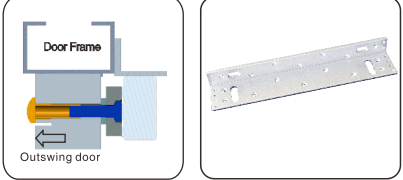
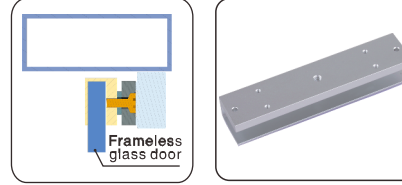
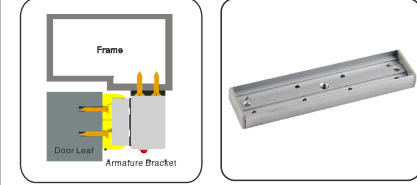
<p>L Bracket-For outward opening door When the door frame thickness is less than 42mm, L bracket is needed.</p> 	<p>U Bracket For the frameless glass door. U bracket is needed.</p> 	<p>I Bracket for armature plate When the door frame is too thick, I bracket is needed.</p> 
--	--	---

Installation Instruction

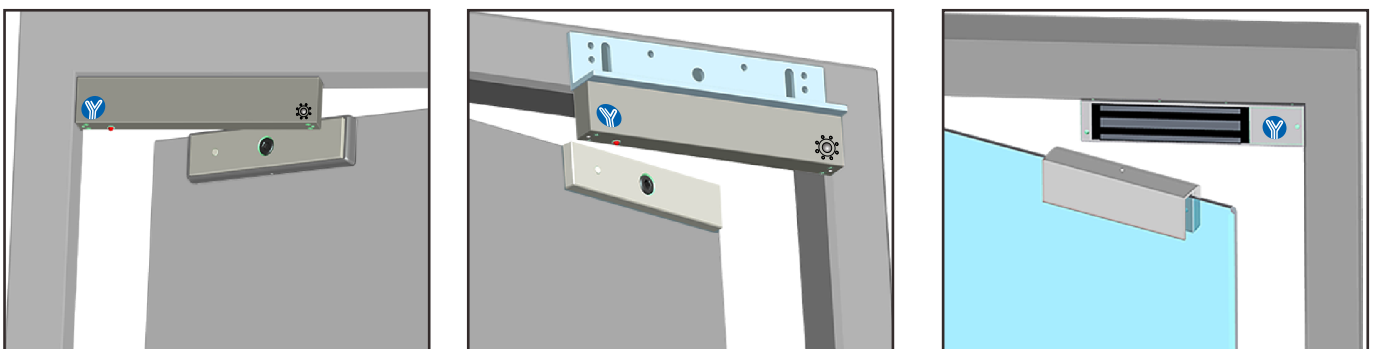

Demonstration of I Bracket Installation

Demonstration of L Bracket Installation

Demonstration of UL Bracket Installation

Circuit Board Diagram

A. 12VDC Input:
Connect the positive(+)lead from a 12VDC power source to V +.
Connect the ground(-)lead from a 12VDC power source to V -.

B. 24VDC Input:
Connect the positive(+)lead from a 24VDC power source to V +.
Connect the ground(-)lead from a 24VDC power source to V -.

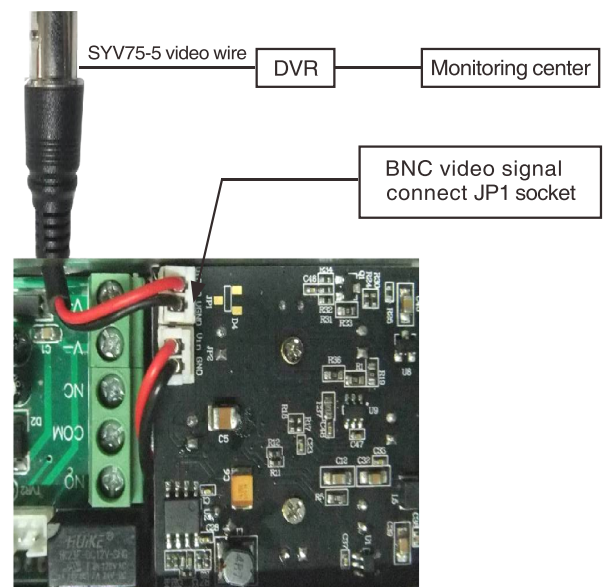
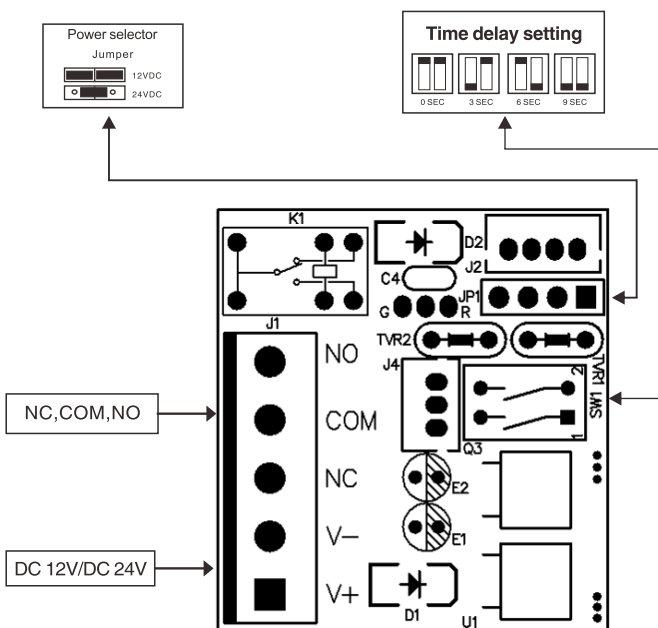

Wire Connection

